

|           |       |
|-----------|-------|
| PROJECT   | _____ |
| TYPE      | _____ |
| SPECIFIER | _____ |
| QUANTITY  | _____ |
| DATE      | _____ |

## VICTORY ACOUSTIC LIGHT PANEL SUSPENSION

### A300747-

|             |             |                   |                    |                |              |
|-------------|-------------|-------------------|--------------------|----------------|--------------|
| base number | LED Dimming | Color Temperature | Finishes (Diamond) | Finish Options | Cable Length |
|-------------|-------------|-------------------|--------------------|----------------|--------------|

- To build a product code in our configurator select the specify button on the base model # product page
- To build a manual product code on this datasheet choose from the options listed below in blue font and add the suffix to the base model #

#### GENERAL

|                                      |
|--------------------------------------|
| Series: Victory Acoustic Light Panel |
| Brand: Prolicht                      |
| Division: Architectural              |
| Mounting Type: Suspension            |
| Mounting Location: Ceiling           |
| Subcategory: Acoustic                |

#### PHYSICAL

|  |
|--|
| Shape: Abstract  |
| Length (mm): 496   |
| Length (in): 19 1/2  |
| Width (mm): 448  |
| Width (in): 17 5/8   |
| Height (mm): 54  |
| Height (in): 2 1/8   |
| Light Distribution: Indirect   |
| Fixture Finish: SSR / BKV / CWI / CRY / HAB / UFT / ITA / RUA / FTG / MYG / LOD / PUS / FRO / FUP / KIA / POP / BLS / SPG / MEY / GOH / GUM / CHC / COM / ABZ / JAG / OBR / MOS / ROR                        |
| Accent Finish: ANC / ASH / BNA / BTC / BZE / CEL / EGG / EVG / FOG / FOS / FST / FUA / IRI / IRO / KHA / LIC / LIM / MER / MSN / MUS / ONX / PEA / PLU / POL / PPY / RAY / ROY / RST / STE / SWD / TAN / TAU |
| Fixture Material: Aluminum   |
| Cable Details: 2 000mm / 78 3/4" or 6 000mm / 236 1/4" Transparent Cable   |

#### ELECTRICAL

|   |
|---|
| Lamp Type: LED (Zhaga Standard)           |
| Input Wattage (W): 10                     |
| Total Output Wattage (W): 9.1             |
| Dimming: Non-Dimmable                     |
| Driver Included: Yes                      |
| Driver Location: Integrated               |
| Driver Type: Constant Current - Universal |
| Driver Class: Class 2                     |
| Input Voltage (V): 120 - 277              |

#### LED

|   |
|---|
| Color Temperature (°K): 2700 / 3000 / 3500 / 4000 |
| Max. Delivered Lumen (lm): 701 / 708 / 730 / 751  |
| Nominal Lumen (lm): 855 / 864 / 890 / 916         |
| CRI: >90 CRI                                      |
| Lamp Life (hrs): 50000                            |

#### OPTICAL

#### RATINGS AND CERTIFICATIONS

|   |
|---|
| Certified By: CSA Certified to UL and CSA Standards |
| IP rating: IP20                                     |

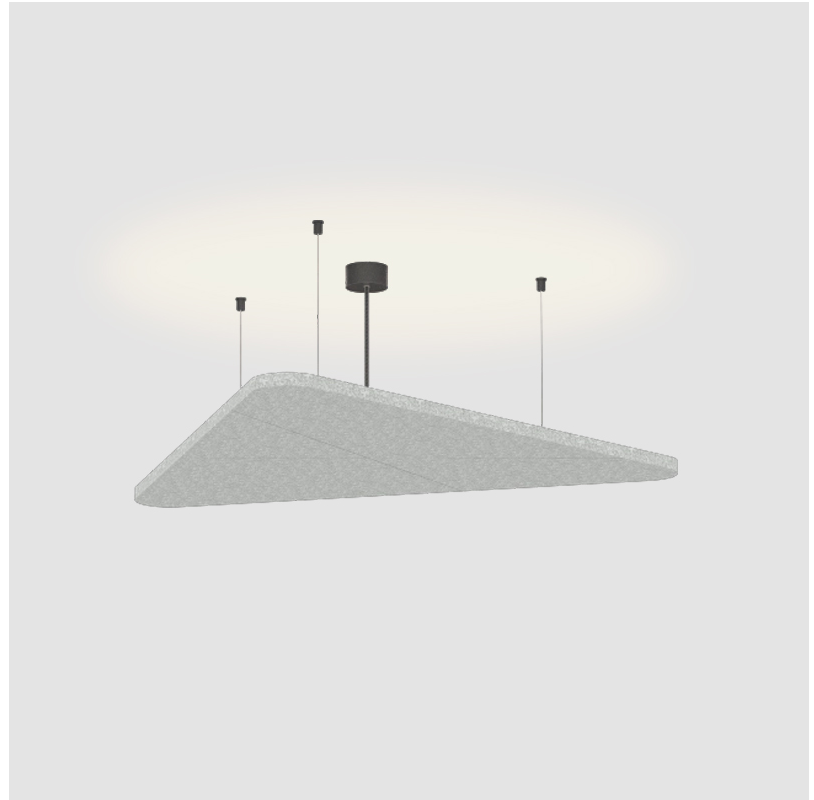

## VICTORY ACOUSTIC LIGHT PANEL SUSPENSION

A300747-

|           |       |
|-----------|-------|
| PROJECT   | _____ |
| TYPE      | _____ |
| SPECIFIER | _____ |
| QUANTITY  | _____ |
| DATE      | _____ |



A

|           |  |
|-----------|--|
| PROJECT   |  |
| TYPE      |  |
| SPECIFIER |  |
| QUANTITY  |  |
| DATE      |  |

## VICTORY ACOUSTIC LIGHT PANEL SUSPENSION

### A300748-

|             |             |                   |                    |                |              |
|-------------|-------------|-------------------|--------------------|----------------|--------------|
| base number | LED Dimming | Color Temperature | Finishes (Diamond) | Finish Options | Cable Length |
|-------------|-------------|-------------------|--------------------|----------------|--------------|

- To build a product code in our configurator select the specify button on the base model # product page
- To build a manual product code on this datasheet choose from the options listed below in blue font and add the suffix to the base model #

#### GENERAL

|                                      |
|--------------------------------------|
| Series: Victory Acoustic Light Panel |
| Brand: Prolicht                      |
| Division: Architectural              |
| Mounting Type: Suspension            |
| Mounting Location: Ceiling           |
| Subcategory: Acoustic                |

#### PHYSICAL

|  |
|--|
| Shape: Abstract  |
| Length (mm): 792   |
| Length (in): 31 <sup>7</sup> / <sub>16</sub>   |
| Width (mm): 704  |
| Width (in): 27 <sup>11</sup> / <sub>16</sub>   |
| Height (mm): 54  |
| Height (in): 2 <sup>1</sup> / <sub>8</sub>   |
| Light Distribution: Indirect   |
| Fixture Finish: SSR / BKV / CWI / CRY / HAB / UFT / ITA / RUA / FTG / MYG / LOD / PUS / FRO / FUP / KIA / POP / BLS / SPG / MEY / GOH / GUM / CHC / COM / ABZ / JAG / OBR / MOS / ROR                        |
| Accent Finish: ANC / ASH / BNA / BTC / BZE / CEL / EGG / EVG / FOG / FOS / FST / FUA / IRI / IRO / KHA / LIC / LIM / MER / MSN / MUS / ONX / PEA / PLU / POL / PPY / RAY / ROY / RST / STE / SWD / TAN / TAU |
| Fixture Material: Aluminum   |
| Cable Details: 2 000mm / 78 3/4" or 6 000mm / 236 1/4" Transparent Cable   |

#### ELECTRICAL

|   |
|---|
| Lamp Type: LED (Zhaga Standard)           |
| Input Wattage (W): 10                     |
| Total Output Wattage (W): 9.1             |
| Dimming: Non-Dimmable                     |
| Driver Included: Yes                      |
| Driver Location: Integrated               |
| Driver Type: Constant Current - Universal |
| Driver Class: Class 2                     |
| Input Voltage (V): 120 - 277              |

#### LED

|   |
|---|
| Color Temperature (°K): 2700 / 3000 / 3500 / 4000 |
| Max. Delivered Lumen (lm): 701 / 708 / 730 / 751  |
| Nominal Lumen (lm): 855 / 864 / 890 / 916         |
| CRI: >90 CRI                                      |
| Lamp Life (hrs): 50000                            |

#### OPTICAL

#### RATINGS AND CERTIFICATIONS

|   |
|---|
| Certified By: CSA Certified to UL and CSA Standards |
| IP rating: IP20                                     |

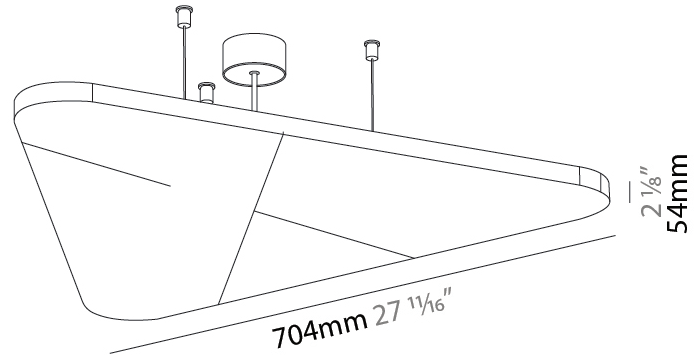
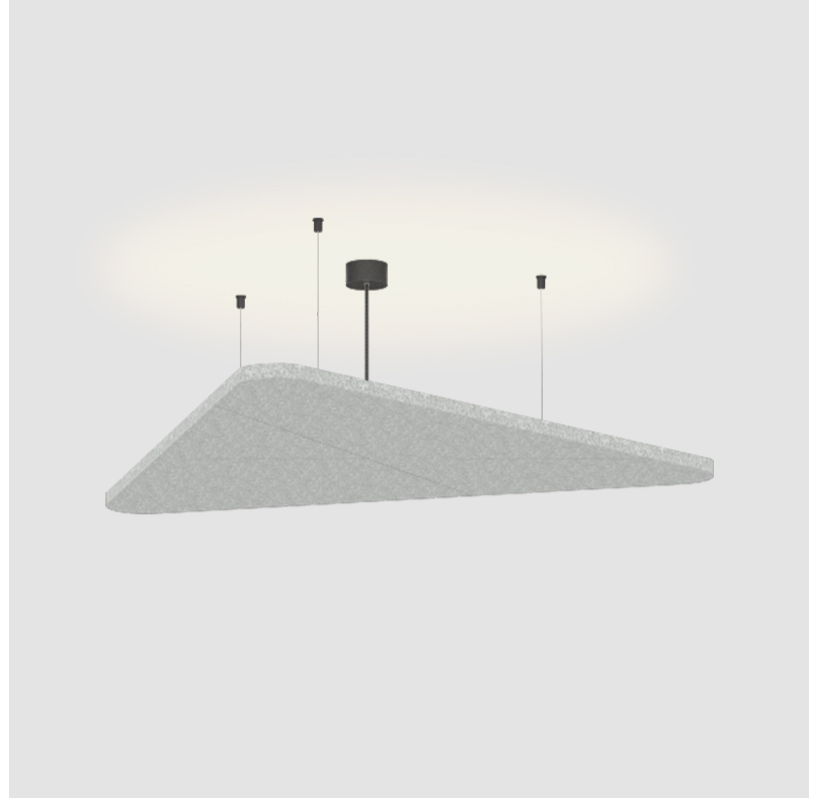

## VICTORY ACOUSTIC LIGHT PANEL SUSPENSION

A300748-

|           |       |
|-----------|-------|
| PROJECT   | _____ |
| TYPE      | _____ |
| SPECIFIER | _____ |
| QUANTITY  | _____ |
| DATE      | _____ |



|           |       |
|-----------|-------|
| PROJECT   | _____ |
| TYPE      | _____ |
| SPECIFIER | _____ |
| QUANTITY  | _____ |
| DATE      | _____ |

## VICTORY ACOUSTIC LIGHT PANEL SUSPENSION

### A300749-

|             |             |                   |                    |                |              |
|-------------|-------------|-------------------|--------------------|----------------|--------------|
| base number | LED Dimming | Color Temperature | Finishes (Diamond) | Finish Options | Cable Length |
|-------------|-------------|-------------------|--------------------|----------------|--------------|

- To build a product code in our configurator select the specify button on the base model # product page
- To build a manual product code on this datasheet choose from the options listed below in blue font and add the suffix to the base model #

#### GENERAL

|                                      |
|--------------------------------------|
| Series: Victory Acoustic Light Panel |
| Brand: Prolicht                      |
| Division: Architectural              |
| Mounting Type: Suspension            |
| Mounting Location: Ceiling           |
| Subcategory: Acoustic                |

#### PHYSICAL

|  |
|--|
| Shape: Abstract  |
| Length (mm): 1092  |
| Length (in): 43  |
| Width (mm): 964  |
| Width (in): 37 <sup>15</sup> / <sub>16</sub>   |
| Height (mm): 54  |
| Height (in): 2 <sup>1</sup> / <sub>8</sub>   |
| Light Distribution: Indirect   |
| Fixture Finish: SSR / BKV / CWI / CRY / HAB / UFT / ITA / RUA / FTG / MYG / LOD / PUS / FRO / FUP / KIA / POP / BLS / SPG / MEY / GOH / GUM / CHC / COM / ABZ / JAG / OBR / MOS / ROR                        |
| Accent Finish: ANC / ASH / BNA / BTC / BZE / CEL / EGG / EVG / FOG / FOS / FST / FUA / IRI / IRO / KHA / LIC / LIM / MER / MSN / MUS / ONX / PEA / PLU / POL / PPY / RAY / ROY / RST / STE / SWD / TAN / TAU |
| Fixture Material: Aluminum   |
| Cable Details: 2 000mm / 78 3/4" or 6 000mm / 236 1/4" Transparent Cable   |

#### ELECTRICAL

|   |
|---|
| Lamp Type: LED (Zhaga Standard)           |
| Input Wattage (W): 23.8                   |
| Total Output Wattage (W): 21.8            |
| Dimming: Non-Dimmable                     |
| Driver Included: Yes                      |
| Driver Location: Integrated               |
| Driver Type: Constant Current - Universal |
| Driver Class: Class 2                     |
| Input Voltage (V): 120 - 277              |

#### LED

|  |
|--|
| Color Temperature (°K): 2700 / 3000 / 3500 / 4000    |
| Max. Delivered Lumen (lm): 1753 / 1771 / 1824 / 1877 |
| Nominal Lumen (lm): 1753 / 2225 / 2160 / 2290        |
| CRI: >90 CRI   |
| Lamp Life (hrs): 50000                               |

#### OPTICAL

#### RATINGS AND CERTIFICATIONS

|   |
|---|
| Certified By: CSA Certified to UL and CSA Standards |
| IP rating: IP20                                     |

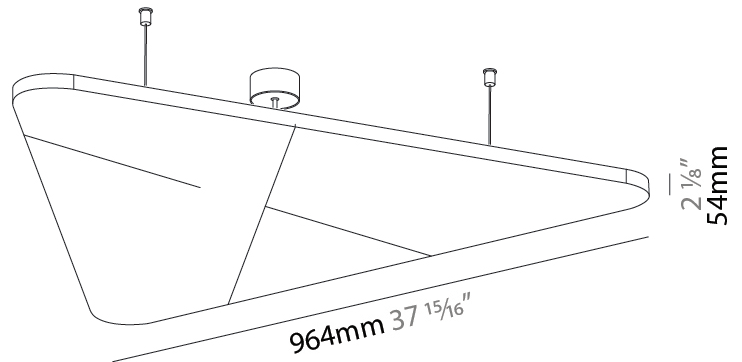
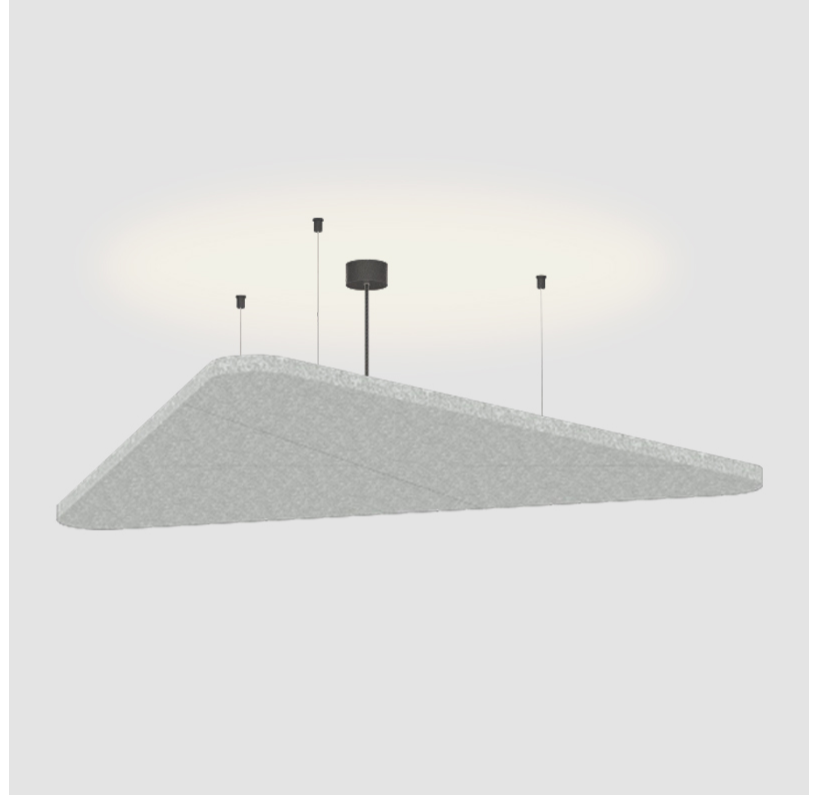

## VICTORY ACOUSTIC LIGHT PANEL SUSPENSION

A300749-

|           |       |
|-----------|-------|
| PROJECT   | _____ |
| TYPE      | _____ |
| SPECIFIER | _____ |
| QUANTITY  | _____ |
| DATE      | _____ |

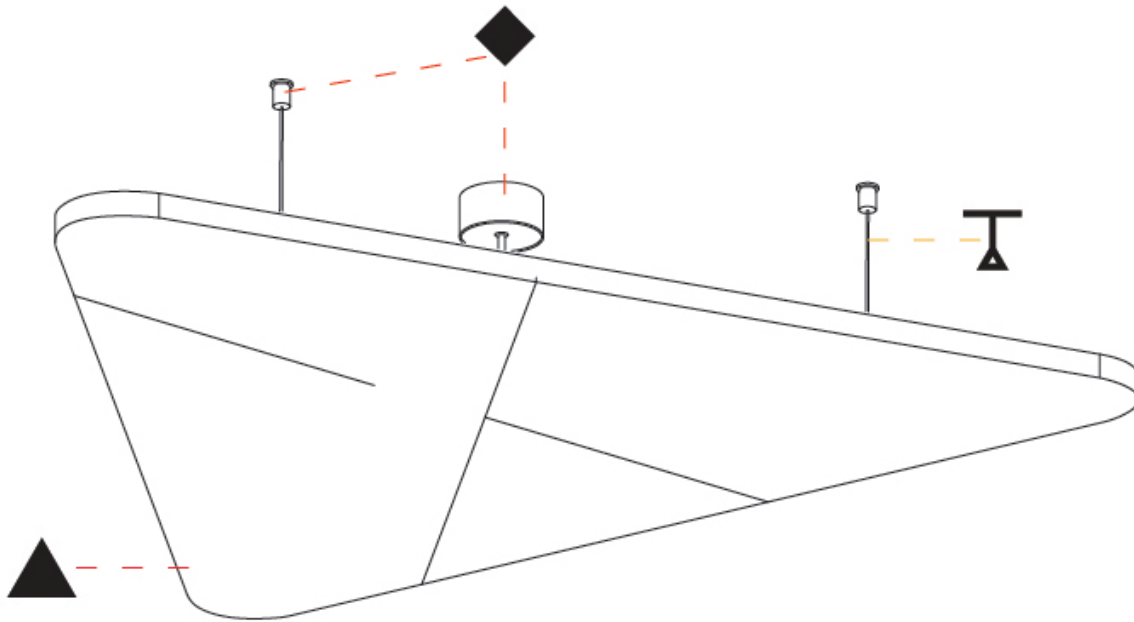

A

## VICTORY ACOUSTIC LIGHT PANEL COLOR FINISH CHART

PROJECT \_\_\_\_\_

TYPE \_\_\_\_\_

SPECIFIER \_\_\_\_\_

QUANTITY \_\_\_\_\_

DATE \_\_\_\_\_

### Fixture Finish

Sparkling Silver - 01 (SSR)



Black Velvet - 02 (BKV)



Crystal White - 03 (CWI)



Creamy - 04 (CRY)



Hampton Bay - 05 (HAB)



Urban Forest - 07 (UFT)



In the Army - 08 (ITA)



Rusty Angel - 09 (RUA)



Fade to Gray - 12 (FTG)



Mysterious Gray - 13 (MYG)



Lost Dream - 15 (LOD)



Purple Sky - 16 (PUS)



Fresh Oh - 17 (FRO)



Funky P. - 18 (FUP)



Kissing Aphrodite - 19 (KIA)



Poseidon's Paradise - 20 (POP)



Blue Sky - 21 (BLS)



Spring Green - 22 (SPG)



Mellow Yellow - 23 (MEY)

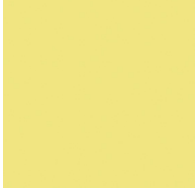

Golden Heart - 24 (GOH)

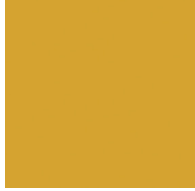

Gun Metal - 25 (GUM)



Champagne Cream - 26 (CHC)



Copper Mine - 27 (COM)



Ancient Bronze - 28 (ABZ)



Jazz Gold - 29 (JAG)



Olive Breeze - 30 (OBR)



Moonlight Silver - 31 (MOS)



Rosewood Red - 32 (ROR)



PROJECT \_\_\_\_\_  
 TYPE \_\_\_\_\_  
 SPECIFIER \_\_\_\_\_  
 QUANTITY \_\_\_\_\_  
 DATE \_\_\_\_\_

## VICTORY ACOUSTIC LIGHT PANEL SUSPENSION COLOR FINISH CHART

### Accent Finish

Anchor - ANC (ANC)

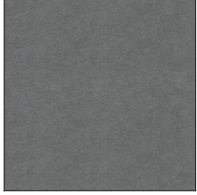

Ash - ASH (ASH)

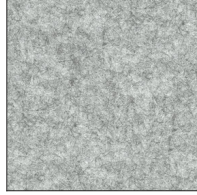

Ballerina - BNA (BNA)



Baltic - BTC (BTC)

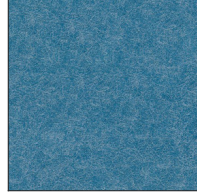

Breeze - BZE (BZE)



Celadon - CEL (CEL)



Eggshell - EGG (EGG)



Evergreen - EVG (EVG)



Fog - FOG (FOG)

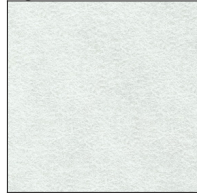

Fossil - FOS (FOS)

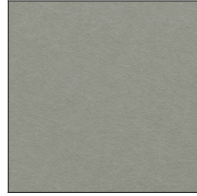

Frost - FST (FST)



Fuchsia - FUA (FUA)

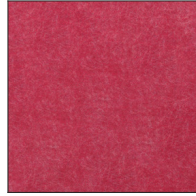

Iris - IRI (IRI)

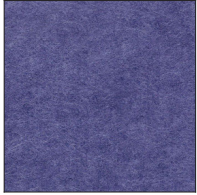

Iron - IRO (IRO)

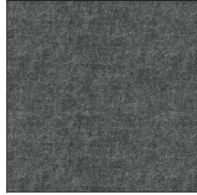

Khaki - KHA (KHA)

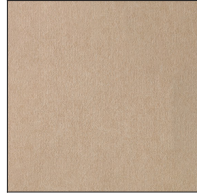

Lichen - LIC (LIC)

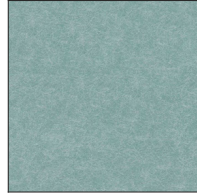

Lime - LIM (LIM)



Merlot - MER (MER)



Muslin - MSN (MSN)

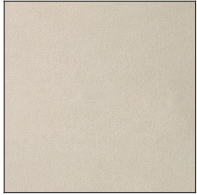

Mustard - MUS (MUS)

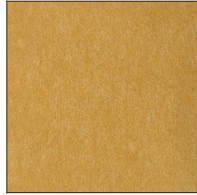

Onyx - ONX (ONX)

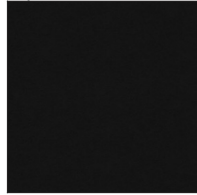

Peach - PEA (PEA)

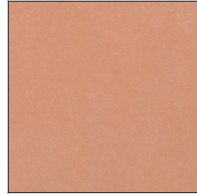

Plum - PLU (PLU)

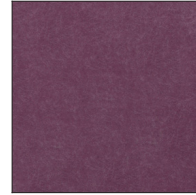

Polar - POL (POL)

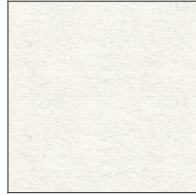

Poppy - PPY (PPY)



Ray - RAY (RAY)

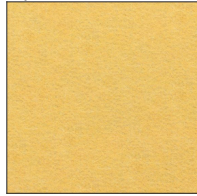

Royal - ROY (ROY)

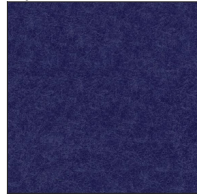

Rust - RST (RST)



Steel - STE (STE)



Seaweed - SWD (SWD)

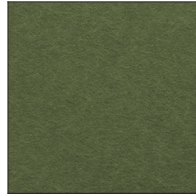

Tangerine - TAN (TAN)

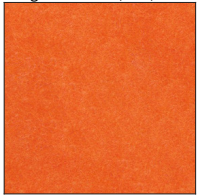

Taupe - TAU (TAU)



**Digital:** Not all screens are calibrated the same, and therefore, colors will appear differently between devices.

**Physical:** When texture is involved, there will be variations in color, character and tone within a product family.

**Gun Metal:** Gun Metal finish is alike to a combination of transparent and black color particles which ensures a highly individual effect and no luminaire being identical.

**Champagne Cream, Copper Mine, Ancient Bronze + Jazz Gold:** These finishes have slight fading from specific powder coating production. Each luminaire will slightly vary.

Available for international specifications by adding 'INT' at the end of the existing Model #. For assistance on 'custom' specifications, contact zteam@zaneen.com.

In a constant effort to supply the best product, we reserve the right to change specifications or materials without notice. The most recent specification sheets are found at zaneen.com

and between product families.



### LEGEND

|  |   |   |  |   |  |
|--|---|---|--|---|--|
|    | floor-mounted   |    | pivotal  |    | special LED (upon request) RGB, RGBW, tunable, gold+, meat+, art+, fashion+                    |
|    | wall and ceiling: recessed and surface mounted            |    | rotating   |    | warm dim / natural dimming LED   |
|    | ceiling-mounted and wall-mounted                          |    | illuminate tilted  |    | rechargeable battery powered   |
|    | wall-mounted  |    | color of suspension cable                                    |    | fixture with natural vivid LED (upon request)  |
|    | omni-directional light distribution                       |    | length of suspension cable                                   |    | color rendering index  |
|    | direct light distribution                                 |    | reflector degree selection                                   |    | color temperature  |
|    | direct/indirect light distribution                        |    | super spot   |    | lumen (luminous flux)  |
|    | indirect light distribution                               |    | lens   |    | efficacy (lumens per watt)   |
|    | asymmetric light distribution                             |    | lens pack  |    | Unified Glare Rating (UGR) range from 5-40   |
|    | aura light distribution                                   |    | shine ring   |    | marine grade (AISI 316 stainless steel)  |
|    | round wall or ceiling cut-out                             |    | integrated shine ring with diffuser                          |    | walk on  |
|    | square wall or ceiling cut-out                            |    | free individual colors 01-29                                 |    | drive on   |
|    | the supplied jig specifies the cutout dimensions          |    | individual colors: 00 (free of charge), 01-25 (extra charge) |    | Dark Sky Compliance  |
|    | minimum distance (meters) lamp - object                   |    | luminaire part to be colored (F1)                            |    | Americans with Disabilities Act (less than 4" off the wall located between 27"-84" from floor) |
|    | recessed depth  |    | luminaire part to be colored (F2)                            |    | lamp protected against explosion   |
|   | ceiling thickness in mm                                   |   | luminaire part to be colored (F3)                            |   | blown glass using traditional methods by master glass blower                                   |
|  | ceiling thickness selection                               |  | luminaire part to be colored (F4)                            |  | acoustic material  |
|  | dimmable DP (phase), DV (0-10V), DD (dali), DS (step-dim) |  | luminaire part to be colored (F5)                            |  | protection class I, protection insulation  |
|  | included or excluded LED driver/transformer/control gear  |  | color of 3-circuit adaptor                                   |  | protection class II, protection insulation   |
|  | separately switchable                                     |  | indirect diffuser  |  | ETL Certified to UL and CSA Standards  |
|  | sensor  |  | direct diffuser  |  | UL Certified to UL and CSA Standards   |
|  | remote control  |  | ball-proof (upon request)                                    |  | CSA Certified to UL and CSA Standards  |
|  | available upon request                                    |  | accessory  |  | Certified for North American Standards   |

### IP RATING

|   |  |
|---|--|
|  | protected against ingress of solid bodies greater than 12.5mm (finger)   |
|  | protected against ingress of solid bodies greater than 2.5mm<br>protected against sprays of water up to 60 degrees from the vertical (rain)      |
|  | protected against ingress of solid bodies greater than 1mm (wire)<br>no protection against the ingress of moisture                               |
|  | protected against ingress of solid bodies greater than 1mm (wire)<br>protected against sprays of water up to 60 degrees from the vertical (rain) |
|  | protected against ingress of solid bodies greater than 1mm (wire)<br>protected against water splashed from all directions                        |
|  | protected against limited ingress of dust (wet rooms/covered outdoor areas)<br>protected against water splashed from all directions              |
|  | protected against ingress of dust<br>protected against jets of water   |
|  | protected against ingress of dust<br>protected against powerful jets of water or heavy seas  |
|  | protected against ingress of dust<br>protected against immersion of water between 15cm - 1m for 30 minutes                                       |
|  | protected against ingress of dust<br>protected against immersion of water under pressure for long periods  |

### IK RATING

|   |   |
|---|---|
|  | protected against 0.14 joules impact (equivalent to 0.25kg mass dropped from 56mm above the surface)  |
|  | protected against 0.2 joules impact (equivalent to 0.25kg mass dropped from 80mm above the surface)   |
|  | protected against 0.35 joules impact (equivalent to 0.25kg mass dropped from 140mm above the surface) |
|  | protected against 0.5 joules impact (equivalent to 0.25kg mass dropped from 200mm above the surface)  |
|  | protected against 0.7 joules impact (equivalent to 0.25kg mass dropped from 280mm above the surface)  |
|  | protected against 1 joules impact (equivalent to 0.25kg mass dropped from 400mm above the surface)    |
|  | protected against 2 joules impact (equivalent to 0.5kg mass dropped from 400mm above the surface)     |
|  | protected against 5 joules impact (equivalent to 1.7kg mass dropped from 300mm above the surface)     |
|  | protected against 10 joules impact (equivalent to 5.0kg mass dropped from 200mm above the surface)    |
|  | protected against 20 joules impact (equivalent to 5.0kg mass dropped from 400mm above the surface)    |